

TRISK | DeVilbiss

TRUCure
IR2S

TRU-CURE IR2S



TC-IR2S-01 (904100 FOR USA)	TRU-CURE IR2S (NORTH AMERICA)
TC-IR2S-02	TRU-CURE IR2S (UNITED KINGDOM)
TC-IR2S-03	TRU-CURE IR2S (EUROPE)



For other languages of this service manual as well as additional product information, please scan the QR code above.



EC Declaration of conformity

According to testing institutes and according to the machine directive the Trisk Devilbiss products in this manual are not defined as machines, wherefore the machine directive reference cannot be included in this declaration.

Manufacturer:

Hedson Technologies AB
Box 1530
SE 462 28 Vänersborg
Sweden

declare under our sole responsibility that the products

Trisk Devilbiss models; TC-IR2S-01 (904100 FOR USA), TC-IR2S-02, TC-IR2S-03

that are used to accelerate the drying of paint, to which this declaration relates, are in conformity with the following standards

EN 60335-1:2012/ EN 60335-1:2012/AC:2014 EN 60335-1:2012/A11:2014 EN 60335-1:2012/A13:2017	Household and similar electrical appliances - Safety - Part 1: General requirements Corrigendum Amendment A11 Amendment A13
EN 60335-2-45:2002 EN 60335-2-45:2002/A1:2008	Particular requirements for portable heating tools and similar appliances Amendment A1
EN 61000-6-3:2021 EN 61000-6-2:2019 EN 61000-3-3:2013/A2:2021 EN 61000-3-12:2011/A1:2024	Electromagnetic compatibility, Generic Emission Standard Electromagnetic compatibility, Generic Immunity Standard Limitation of voltage fluctuations Limits for harmonic current emissions

Compliance:

The EN 61000-3-2 does not apply to this professional equipment. However it complies to EN 61000-3-12 provided that the short circuit power S_{sc} is greater or equal to 300kVA or that the corresponding short circuit current I_{sc} is greater or equal to 430A at interface point between user and public power system.

In accordance with the provisions of the following directives in their most current version

2014/35/EU	Low Voltage Directive
2014/30/EU	Electromagnetic Compatibility
2011/65/EU	RoHS Directive

Vänersborg, Sweden, 1st of February 2023



Linus Ekfeldt
Product Company Director IRT

Declaration of conformity UKCA

Manufacturer, Hedson Technologies AB
Box 1530
SE 462 28 Vänersborg
Sweden

declare under our sole responsibility that the products

Trisk Devilbiss models; TC-IR2S-01 (904100 FOR USA), TC-IR2S-02, TC-IR2S-03

that are used to accelerate the drying of paint, to which this declaration relates, are in conformity with the following standards

BS EN 60335-1:2012/ BS EN 60335-1:2012/AC:2014 BS EN 60335-1:2012/A11:2014 BS EN 60335-1:2012/A13:2017	Household and similar electrical appliances - Safety - Part 1: General requirements Corrigendum Amendment A11 Amendment A13
BS EN60335-2-45:2002 BS EN60335-2-45:2002/A1:2008	Particular requirements for portable heating tools and similar appliances Amendment A1
BS EN 61000-6-3:2021 BS EN 61000-6-2:2019 BS EN 61000-3-3:2013/A2:2021 BS EN 61000-3-12:2011/A1:2024	Electromagnetic compatibility, Generic Emission Standard Electromagnetic compatibility, Generic Immunity Standard Limitation of voltage fluctuations Limits for harmonic current emissions

Compliance:

The BS EN 61000-3-2 does not apply to this professional equipment. However it complies to BS EN 61000-3-12 provided that the short circuit power S_{sc} is greater or equal to 300kVA or that the corresponding short circuit current I_{sc} is greater or equal to 430A at interface point between user and public power system.

In accordance with the provisions of the following directives in their most current version

Electrical Equipment (Safety) Regulations 2016
Electro-magnetic Compatibility Regulations 2016
The Restriction of the Use of Certain Hazardous Substances in Electrical and Electronic Equipment Regulations 2012

Vänersborg, Sweden, 1st of February 2023



Linus Ekfeldt
Product Company Director IRT

In this part sheet, the words **WARNING**, **CAUTION** and **NOTE** are used to emphasize important safety information as follows:

WARNING

Hazards or unsafe practices which could result in severe personal injury, death or substantial property damage.

CAUTION

Hazards or unsafe practices which could result in minor personal injury, product or property damage.

NOTE

Important installation, operation or maintenance information.

WARNING

Read the following warnings before using this equipment.



READ THE MANUAL

Before operating finishing equipment, read and understand all safety, operation and maintenance information provided in the operation manual.



OPERATOR TRAINING

All personnel must be trained before operating finishing equipment.



EQUIPMENT MISUSE HAZARD

Equipment misuse can cause the equipment to rupture, malfunction, or start unexpectedly and result in serious injury.



LOCK OUT / TAG-OUT

Failure to de-energize, disconnect, lock out and tag-out all power sources before performing equipment maintenance could cause serious injury or death.



AUTOMATIC EQUIPMENT

Automatic equipment may start suddenly without warning.



PRESSURE RELIEF PROCEDURE

Always follow the pressure relief procedure in the equipment instruction manual.



KEEP EQUIPMENT GUARDS IN PLACE

Do not operate the equipment if the safety devices have been removed.



KNOW WHERE AND HOW TO SHUT OFF THE EQUIPMENT IN CASE OF AN EMERGENCY



WEAR SAFETY GLASSES

Failure to wear safety glasses with side shields could result in serious eye injury or blindness.



INSPECT THE EQUIPMENT DAILY

Inspect the equipment for worn or broken parts on a daily basis. Do not operate the equipment if you are uncertain about its condition.



NEVER MODIFY THE EQUIPMENT

Do not modify the equipment unless the manufacturer provides written approval.



NOISE HAZARD

You may be injured by loud noise. Hearing protection may be required when using this equipment.

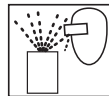

PROJECTILE HAZARD

You may be injured by venting liquids or gases that are released under pressure, or flying debris.



PINCH POINT HAZARD

Moving parts can crush and cut. Pinch points are basically any areas where there are moving parts.



STATIC CHARGE

Fluid may develop a static charge that must be dissipated through proper grounding of the equipment, objects to be sprayed and all other electrically conductive objects in the dispensing area. Improper grounding or sparks can cause a hazardous condition and result in fire, explosion or electric shock and other serious injury.



WEAR RESPIRATOR

Toxic fumes can cause serious injury or death if inhaled. Wear a respirator as recommended by the fluid and solvent manufacturer's Safety Data Sheet.



TOXIC FLUID & FUMES

Hazardous fluid or toxic fumes can cause serious injury or death if splashed in the eyes or on the skin, inhaled, injected or swallowed. LEARN and KNOW the specific hazards or the fluids you are using.



FIRE AND EXPLOSION HAZARD

Improper equipment grounding, poor ventilation, open flame or sparks can cause a hazardous condition and result in fire or explosion and serious injury.



MEDICAL ALERT

Any injury caused by high pressure liquid can be serious. If you are injured or even suspect an injury:

- Go to an emergency room immediately.
- Tell the doctor you suspect an injection injury.
- Show the doctor this medical information or the medical alert card provided with your airless spray equipment.
- Tell the doctor what kind of fluid you were spraying or dispensing.



GET IMMEDIATE MEDICAL ATTENTION

To prevent contact with the fluid, please note the following:

- Never point the gun/valve at anyone or any part of the body.
- Never put hand or fingers over the spray tip.
- Never attempt to stop or deflect fluid leaks with your hand, body, glove or rag.
- Always have the tip guard on the spray gun before spraying.
- Always ensure that the gun trigger safety operates before spraying.

IT IS THE RESPONSIBILITY OF THE EMPLOYER TO PROVIDE THIS INFORMATION TO THE OPERATOR OF THE EQUIPMENT. FOR FURTHER SAFETY INFORMATION REGARDING THIS EQUIPMENT, SEE THE GENERAL EQUIPMENT SAFETY BOOKLET (77-5300).

TRU CURE IR2S – GENERAL INFORMATION

FIELD OF APPLICATION

The Trisk Devilbiss IR2S are designed to provide an accelerated and even cure of most automotive refinishing materials. Typically drying of putty, filler, base and top coats, both water-based and solvent-based products. Its site of use is the preparation area and finishing area. Within the automotive industry and vehicle repair sectors, it is used to dry small areas and cure materials before polishing .

PRODUCT DESCRIPTION

The easily maneuverable Trisk Devilbiss IR2S are equipped with both dual and single lamp cassettes for easy adjustment and flexibility around curved parts without sacrifice to heat distribution. The design makes cassette adjustment simple. The IR lamps and reflectors are protected against mechanical damage with a mesh.

PARTICULAR ADVANTAGES

Unique reflector design

The Trisk Devilbiss IR2S features a unique dimpled sheet reflector that generates extremely even curing intensity and temperature over entire surfaces. This ensures the fastest possible curing time, while minimizing risk of over-curing or burning sections of your coating.

TECHNICAL DATA

Electrical diagram, see page 9.

Rated Voltage	220V - 240 V, 50/60Hz Single Phase
Rated power	2 emitters, full power 2000 W
Heating elements	2 quartz, tungsten filament, Infrared emitters
Fuse*	10 A slow, type C (NA 15 A)
Weight	29 kg
Noise level	Less than 70 dB (A)
Max ambient temperature during operation	40°C
Max ambient temperature during storage and transportation	70°C

* The dryer must be supplied by recommended fuse.

INSTRUCTION TO THE OWNER

The owner of the mobile dryer must produce clear operating instructions, adapted to local site conditions and applicable national / regional requirements, and make these available to all users.

Mobile dryer users must adhere to these operating instructions. The mobile dryer user must always ensure that sufficient technical ventilation is complied in accordance with the applicable national / regional requirements.

This appliance is not intended for use by persons (including children) with reduced physical, sensory or mental capabilities, or lack of experience and knowledge, unless they have been given supervision or instruction concerning use of the appliance by a person responsible for their safety. Children should be supervised to ensure that they do not play with the appliance.

Dispose of spent items at the nearest environmental protection facility for recycling.

WARNINGS

FIRE AND EXPLOSION

Do not use in an area until it is checked and cleared of combustible and/or flammable materials.

Do not use in an area where the air may contain flammable dust, gas, or liquid vapors.

Never direct the heating equipment towards any pressurized vessel.

Never direct the heating equipment towards combustible or flammable materials.

If you have a distance less than 60 cm/2 feet to the object the temperature might raise quickly and the risk for fire increases.

ELECTRICAL EQUIPMENT

The mobile dryer is operated by highly dangerous electrical voltage.

ACCESSING ELECTRICAL EQUIPMENT

Before accessing live parts, remove the main connector from the wall socket. Only professional electricians may have direct access into the electrical equipment.

If the supply cord is damaged, it must be replaced by the manufacturer, its service agent or similarly qualified persons in order to avoid a hazard.

WARNING!

Intensive heat radiation. Hands, face and other parts of the body should be exposed as little as possible to the heat radiation.

TRU CURE IR2S – OPERATING INSTRUCTIONS**IR2S – OPERATIONS**

Insert the plug in a grounded electrical outlet.

Switch the circuit breaker in back of the cassette.

The lamp will illuminate and full output will be reached within a few seconds.

To turn off the equipment, switch the circuit breaker in back of the cassette once again.

By radiating only the needed areas and not heating any air, a lower energy consumption is achieved.

Optimum distance is 50-60 cm.

NOTES
Minimum curing distance is 50 cm and optimal curing distance is 60 cm.

MAINTENANCE

LAMP REPLACEMENT

NOTE

Only use original Trisk Devilbiss lamps with the correct power rating.

1. Disconnect power supply.
2. Remove the mesh.
3. Remove the old lamp.
4. Install new lamp in reverse order.



CAUTION

Do not touch the new lamp with your fingers. Remove the protective paper on the lamp after you have installed it.

TROUBLESHOOTING

PROBLEM	POSSIBLE CAUSE	POSSIBLE SOLUTION
Solvent popping	Unit too close to panel Insufficient flash off time Paint system has fast thinner	Move unit further away Increase flash off time Use a standard or slow thinner
Undercure or softness of the paint film	Unit too far away Insufficient bake time Excessive film weight	Move unit closer Increase full bake time Apply lighter coats
Softness on the edge of repair	Repair too large for I.R. unit	Split area into two, move unit for 2nd application. If flash off is used, it will not be necessary on 2nd application.
Difficulty in polishing out dirt nibs	Too long on bake cycle Unit too close to panel	Reduce cure time Move unit further away

SPARE PARTS

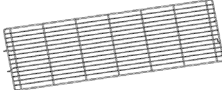
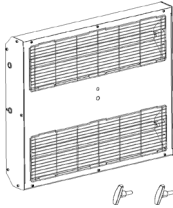
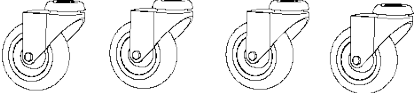
PICTURE	PART NO.	DESCRIPTION
	410-1000 991000 for USA	1 KW IR QUARTS LAMP
	410-1001 991001 for USA	REFLECTOR
	410-1002 991002 for USA	PROTECTIVE MESH
	410-1004 991004 for USA	2 KW CASSETTE COMPLETE IR2S
	410-1013 991013 for USA	CASTOR
	410-1016	CORD SET 5 M (EU)
	410-1015	CORD SET 5 M (UK)
	410-1014 991014 for USA	CORD SET 5 M (NA)

ELECTRICAL DIAGRAM

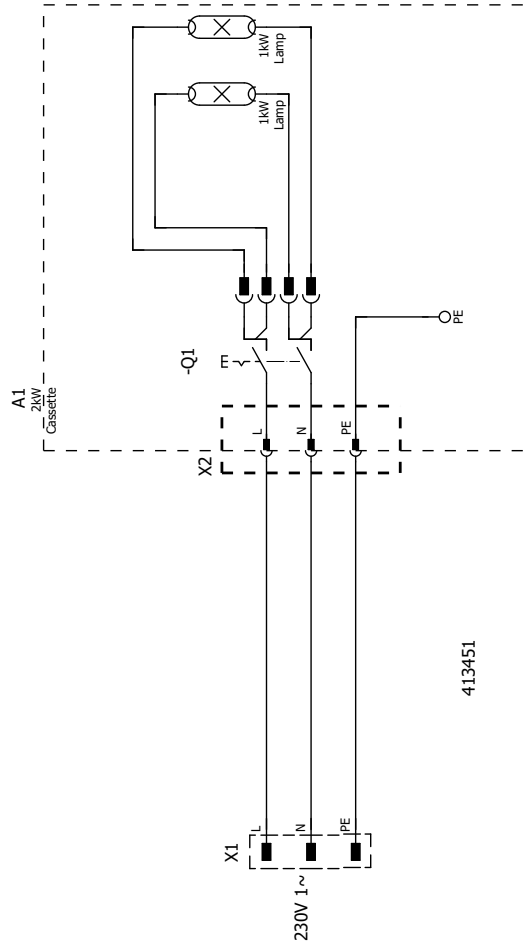

NOTES

Following markings for US and Canada only:

The following contain references to complemented directives and standards to fulfill the US/Canadian market:

Approval for NA Part nos. TC-IR2S-01 (904100 FOR USA)
CSA C22.2 No.88:2019 Ed.2 Industrial Heating Equipment
UL 499:2014 Ed.14+R:14 Jun2022 Electric Heating Appliances

Vänersborg, Sweden, January 2023



Linus Ekfeldt
Product Company Director

NOTES

IR2S – INSTALLATION

⚠ WARNINGS

This unit must not be used in operation near spray painting. This unit must be used outside the hazardous area, class 1 division 1 & 2 and Zone 2.

This mobile dryer must be used outside the hazardous area. For US/Canada 220/240V single phase installations, the male plug for the unit is provided with the unit. This plug must be mated to a female plug with the proper voltage and current rating compatible with an L6-30 receptacle. The connection into the power system must be installed according to local or national electrical code requirements.



Example of NEMA L6-30 Plug

WARRANTY POLICY

This product is covered by Binks' materials and workmanship limited warranty.

The use of parts or accessories from sources other than Binks will void all warranties. Failure to follow reasonable maintenance guidance provided can invalidate the warranty.

For specific warranty information, please contact Binks.

For technical assistance or to locate an authorized distributor, contact one of our international sales and customer support locations listed below.

REGION	BINKS CONTACT
Americas	Tel: 1-800-992-4657
Europe, Africa, Middle East	Tel: +4401202571111
India	marketingroa@binks.com
China	Tel: +862133730108
Korea	Tel: +82313663303
Japan	Tel: +81457856421
Australia	Tel: +61085257555

WARRANTY PAGE



Binks is a global leader in innovative finishing technologies.
Binks reserves the right to modify equipment specifications without prior notice.
Binks®, DeVilbiss® and Ransburg® are registered trademarks of Binks US, LLC.

©2025 Binks US, LLC. All rights reserved.